

REVISIONS				
ZONE	REV	DESCRIPTION	DATE	APPROVED

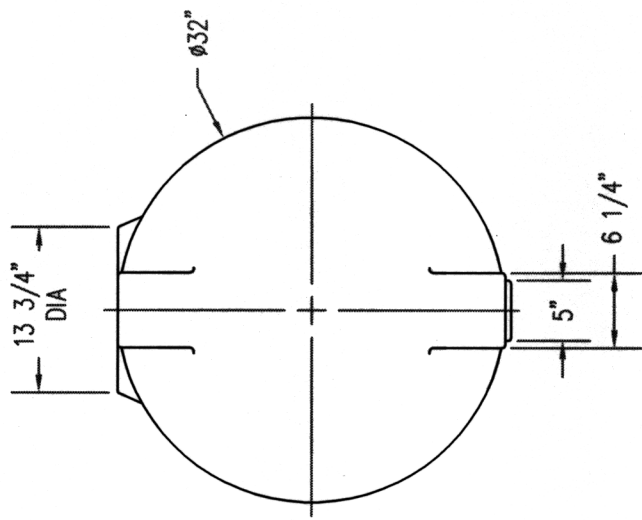
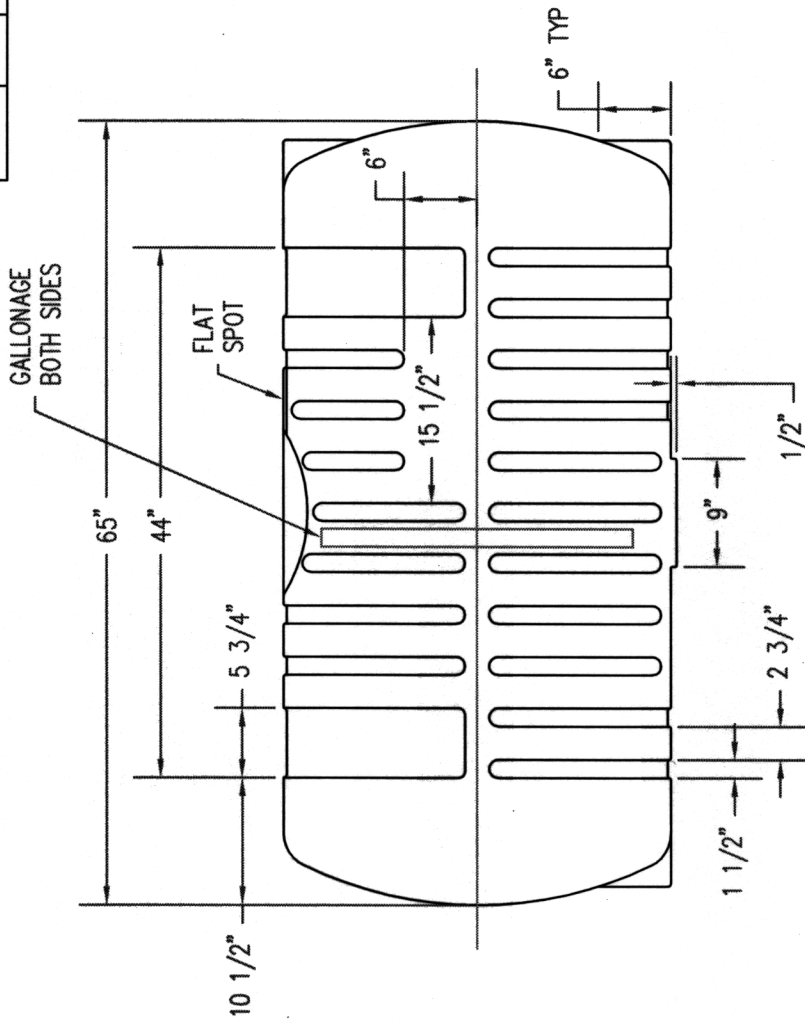

NORWESCO
ST. BONIFACIUS, MN

200 GALLON X 32 DIA
APPLICATOR TANK

JTP 26JUN03	SIZE	FSCM NO.	DWG NO.	REV
	A		47209/47068	
	SCALE	1/16	SHEET	